

Description

The 20KP series is designed specifically to protect sensitive electronic equipment from voltage transients induced by lightning and other transient voltage events.

Features

- Halogen free and RoHS compliant
- Glass passivated junction
- Low incremental surge resistance
- Excellent clamping capability
- 20000W peak pulse power capability at 10/1000 μ s waveform, repetition rate (duty cycle): 0.05%
- Fast response time
- Typical I_R less than 2 μ A above 40V devices
- High Temperature soldering guaranteed: 265 $^{\circ}$ C/10 seconds/.375", (9.5mm) lead length, 5lbs (2.3kg) tension
- Plastic package has underwriters laboratory flammability 94V-0
- Meet MSL level1, per J-STD-020
- IEC-61000-4-2 ESD 30kV(Air), 30kV (Contact)
- Unit Weight: 2.4g



Applications

TVS components are ideal for the protection of I/O Interfaces, VCC bus and other vulnerable circuits used in telecom, computer, Industrial and consumer electronic applications.

Maximum Ratings and Characteristics ($T_A=25^{\circ}$ C)

Rating	Symbol	Value
Peak pulse power dissipation at 10/1000 μ s waveform (Note1, Fig.1)	P_{PPM}	20000W
Peak pulse current of at 10/1000 μ s waveform (Note 1, Fig.3)	I_{PPM}	See Table(A)
Steady state power dissipation at $T_L=75^{\circ}$ C (Fig.5)	$P_{M(AV)}$	8.0W
Peak forward surge current, 8.3ms single half sine-wave superimposed on rated load, (JEDEC Method) (Note2, Fig.6)	I_{FSM}	400A
Operating junction and Storage Temperature Ranges	T_J, T_{STG}	-55 $^{\circ}$ C to +150 $^{\circ}$ C
Typical thermal resistance junction to lead	$R_{\theta JL}$	8 $^{\circ}$ C/W
Typical thermal resistance junction to ambient	$R_{\theta JA}$	40 $^{\circ}$ C/W

Notes:1. Non-repetitive current pulse, per Fig.3 and derating above $T_A=25^{\circ}$ C per Fig.2.

2. 8.3ms single half sine-wave or equivalent square wave, duty cycle=4 pulses per minutes maximum.

Electrical Characteristics (T_A=25°C)

Part Number		Reverse Stand-Off Voltage	Breakdown Voltage @I _T		Test Current	Maximum Clamping Voltage @I _{PP}	Peak Pulse Current	Reverse Leakage @V _R
Uni.	Bi.	V _R (V)	V _{B Min.} (V)	V _{B Max.} (V)	I _T (mA)	V _C (V)	I _{PP} (A)	I _R (μA)
20KP17A	20KP17CA	17.0	18.99	21.22	50	31.0	645.1	3000
20KP20A	20KP20CA	20.0	22.34	24.94	50	36.8	548.9	2000
20KP24A	20KP24CA	24.0	26.81	29.93	50	41.2	490.3	1500
20KP26A	20KP26CA	26.0	29.04	32.42	50	44.7	451.9	1000
20KP28A	20KP28CA	28.0	31.28	34.92	50	48.0	420.8	800
20KP30A	20KP30CA	30.0	33.51	37.41	5	51.5	392.2	250
20KP32A	20KP32CA	32.0	35.74	39.90	5	54.3	372.0	150
20KP34A	20KP34CA	34.0	38.00	42.42	5	57.5	351.3	50
20KP36A	20KP36CA	36.0	40.20	44.88	5	61.5	328.5	20
20KP40A	20KP40CA	40.0	44.70	49.90	5	67.8	297.9	10
20KP44A	20KP44CA	44.0	49.10	54.81	5	72.7	277.9	2
20KP48A	20KP48CA	48.0	53.60	59.83	5	79.4	254.4	2
20KP52A	20KP52CA	52.0	58.10	64.86	5	85.8	235.4	2
20KP56A	20KP56CA	56.0	62.60	69.88	5	92.6	218.1	2
20KP60A	20KP60CA	60.0	67.00	74.79	5	97.6	207.0	2
20KP64A	20KP64CA	64.0	71.50	79.82	5	104.0	194.2	2
20KP68A	20KP68CA	68.0	76.00	84.84	5	110.0	183.6	2
20KP72A	20KP72CA	72.0	80.40	89.75	5	116.0	174.1	2
20KP80A	20KP80CA	80.0	89.40	99.80	5	130.0	155.4	2
20KP88A	20KP88CA	88.0	98.30	109.73	5	142.0	142.3	2
20KP96A	20KP96CA	96.0	107.20	119.67	5	155.0	130.3	2
20KP104A	20KP104CA	104.0	116.20	129.72	5	168.0	120.2	2
20KP112A	20KP112CA	112.0	125.10	139.65	5	182.0	111.0	2
20KP120A	20KP120CA	120.0	134.00	149.59	5	194.0	104.1	2
20KP132A	20KP132CA	132.0	147.40	164.54	5	213.0	94.8	2

Electrical Characteristics ($T_A=25^{\circ}\text{C}$)

Part Number		Reverse Stand-Off Voltage	Breakdown Voltage @ I_T		Test Current	Maximum Clamping Voltage @ I_{PP}	Peak Pulse Current	Reverse Leakage @ V_R
Uni.	Bi.	$V_R(V)$	$V_{B\ Min.}(V)$	$V_{B\ Max.}(V)$	$I_T(mA)$	$V_C(V)$	$I_{PP}(A)$	$I_R(\mu A)$
20KP144A	20KP144CA	144.0	160.80	179.50	5	232.0	87.1	2
20KP160A	20KP160CA	160.0	178.70	199.49	5	258.0	78.3	2
20KP172A	20KP172CA	172.0	192.10	214.44	5	277.0	72.9	2
20KP180A	20KP180CA	180.0	201.10	224.49	5	291.0	69.4	2
20KP192A	20KP192CA	192.0	214.50	239.45	5	309.0	65.4	2
20KP204A	20KP204CA	204.0	227.90	254.41	5	329.0	61.4	2
20KP216A	20KP216CA	216.0	241.30	269.37	5	348.0	58.0	2
20KP232A	20KP232CA	232.0	259.10	289.24	5	374.0	54.0	2
20KP240A	20KP240CA	240.0	268.10	299.28	5	387.0	52.2	2
20KP256A	20KP256CA	256.0	286.00	319.27	5	412.0	49.0	2
20KP280A	20KP280CA	280.0	312.80	349.18	5	451.0	44.8	2
20KP300A	20KP300CA	300.0	335.10	374.08	5	483.0	41.8	2

Ratings and Characteristic Curves ($T_A=25^\circ\text{C}$)

Figure 1. Peak Pulse Power Rating Curve

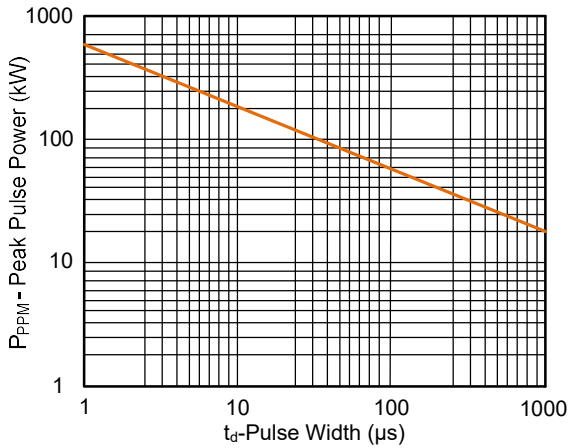

Figure 2. Pulse Derating Curve

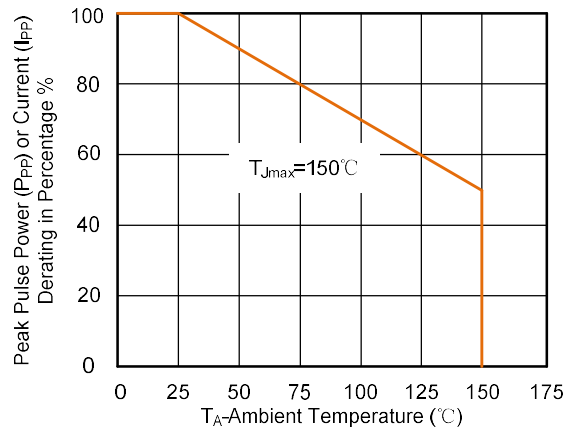

Figure 3. Pulse Waveform

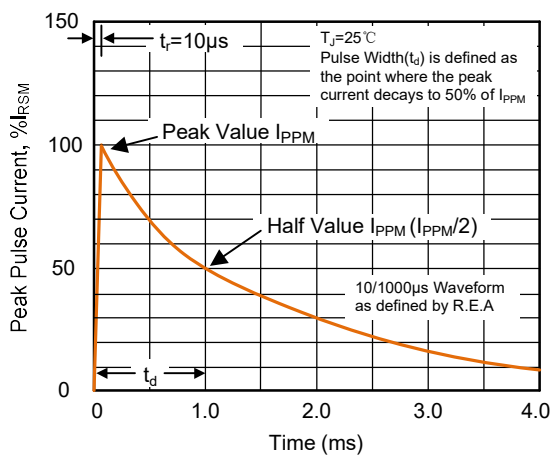

Figure 4. Typical Junction Capacitance

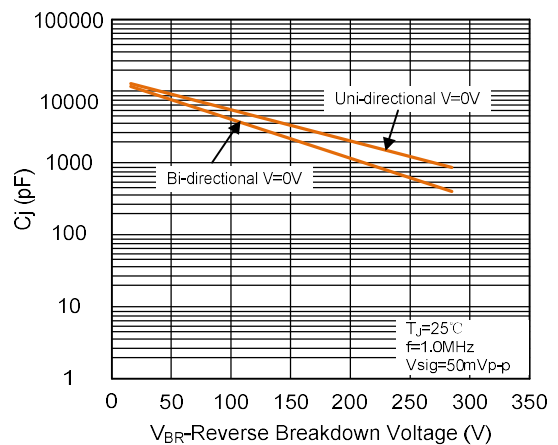

Figure 5. Steady State Power Dissipation Derating Curve

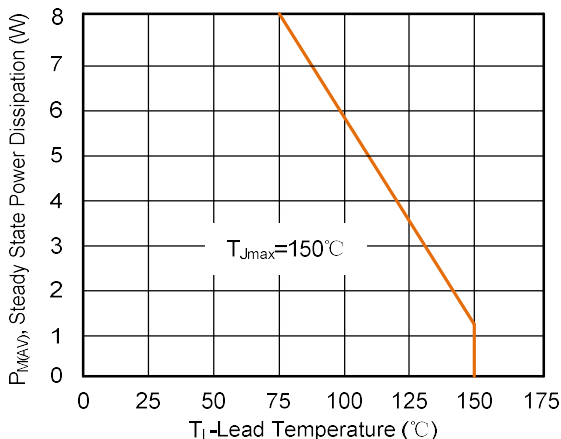
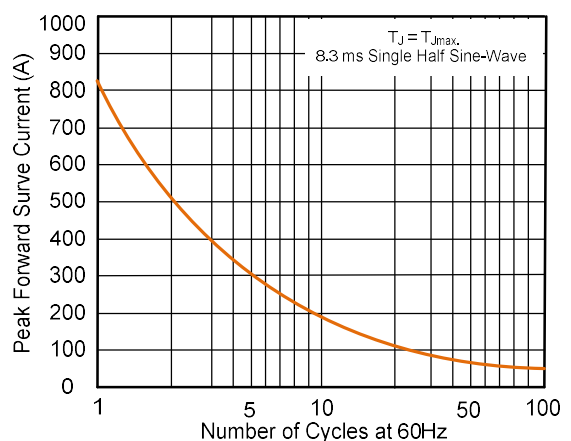
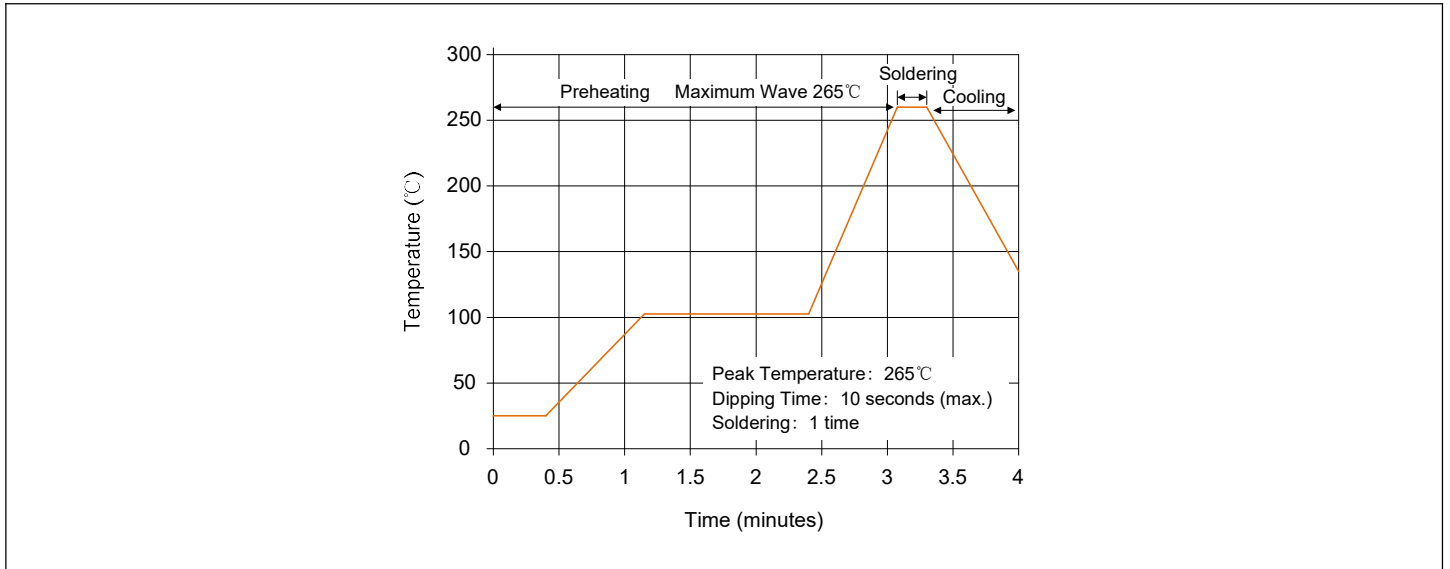

Figure 6. Maximum Non-Repetitive Forward Surge Current Uni-Directional Only



Wave Soldering



Part Number Code and Marking Code

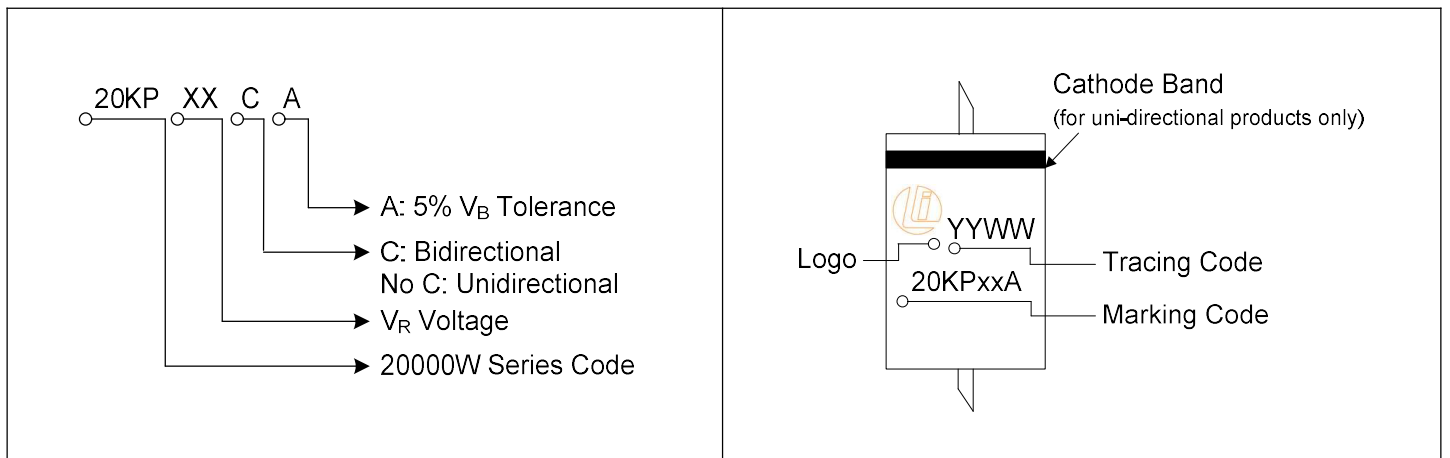

Dimensions (P600)

The diagram shows the dimensions of the diode package. The dimensions are labeled A, B, C, and d.

Symbol	Millimeters		Inches	
	Min.	Max.	Min.	Max.
A	25.40	-	1.000	-
B	8.60	9.10	0.340	0.360
C	8.60	9.10	0.340	0.360
d	1.19	1.35	0.047	0.053

Packaging Specification

Tape

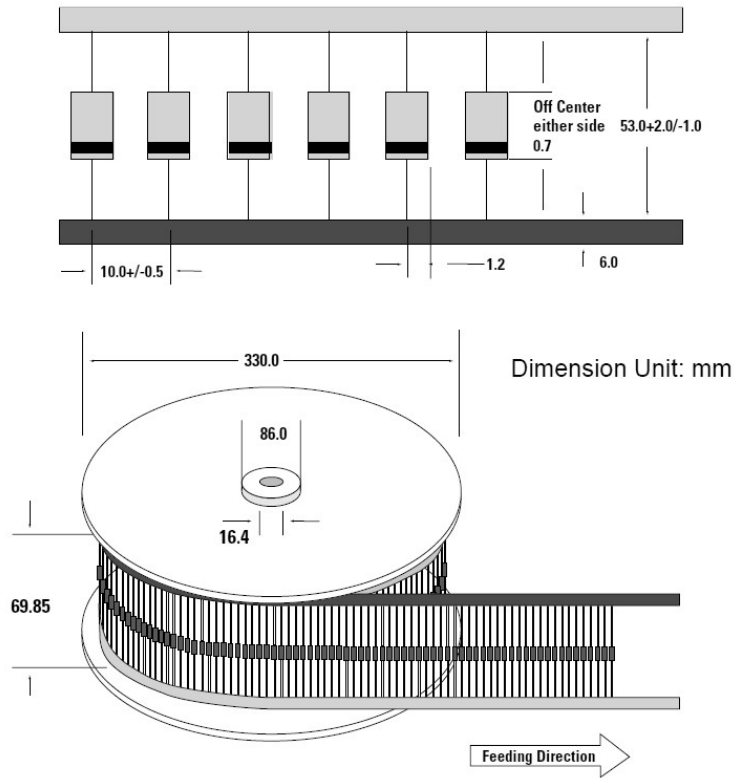

Quantity: 800pcs/reel

Box

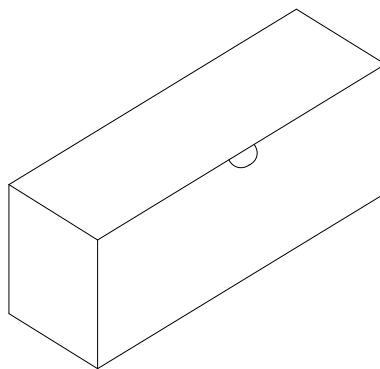

Quantity: 300pcs/box